

# MAHLE

Industry

## Medium Pressure Filter

Pi 340

Nominal pressure 250/315/350 bar (3560/4480/4980 psi), nominal size up to 450  
(also available with filter elements acc. to DIN 24550)

### 1. Features

#### High performance filters for modern hydraulic systems

- Designed for control block mounting
- Modular system
- Compact design
- Minimal pressure drop through optimal flow design
- Visual/electrical/electronic maintenance indicator
- Equipped with highly efficient glass fibre PS filter elements
- Beta rated elements according to ISO 16889 multipass test
- Elements with high differential pressure stability and dirt holding capacity
- Worldwide distribution



## 2. Flow rate/pressure drop curve (filter housing incl. element)

■ 190 mm<sup>2</sup>/s  
■ 33 mm<sup>2</sup>/s

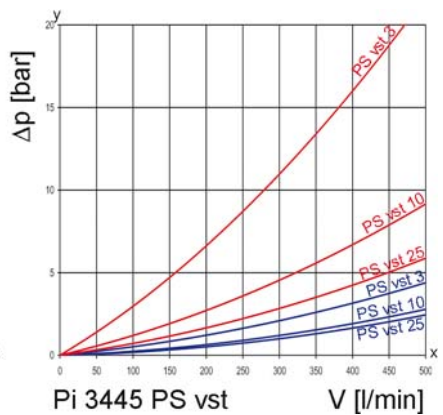
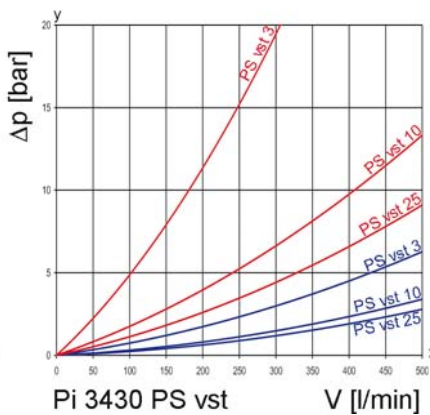
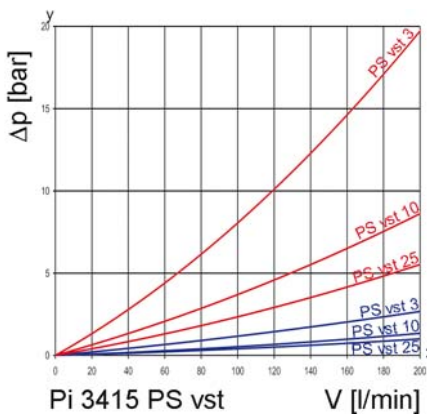
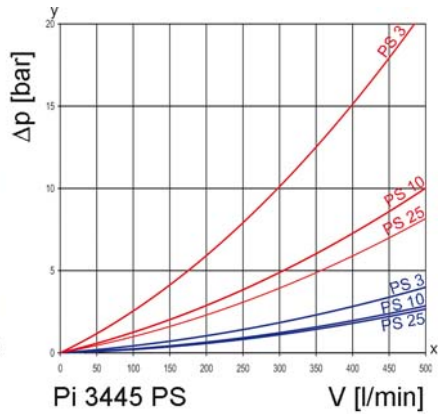
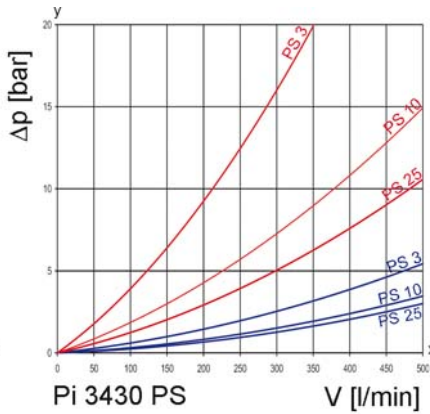
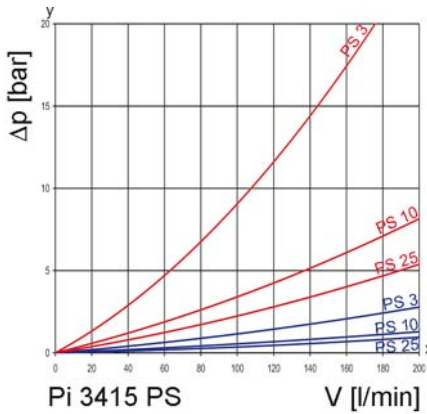
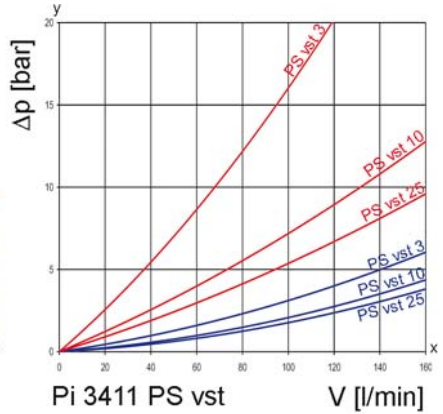
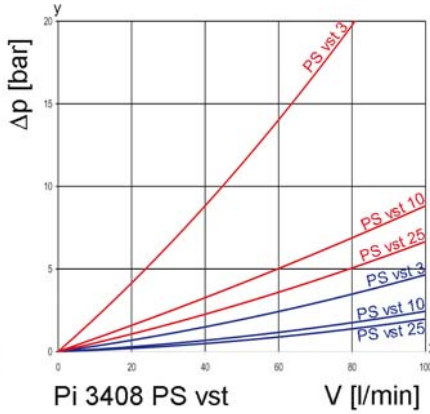
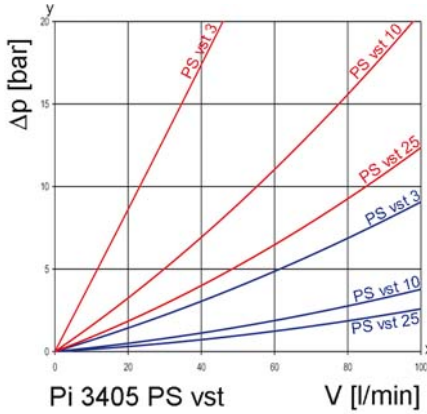
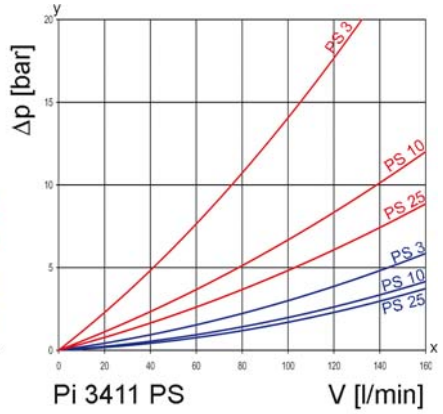
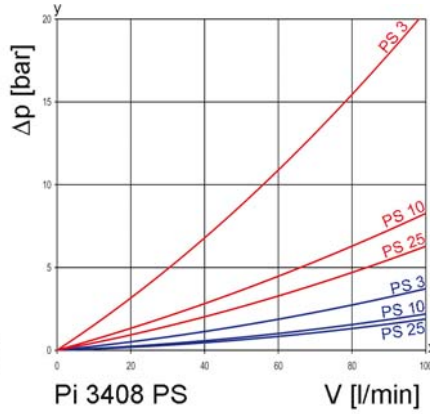
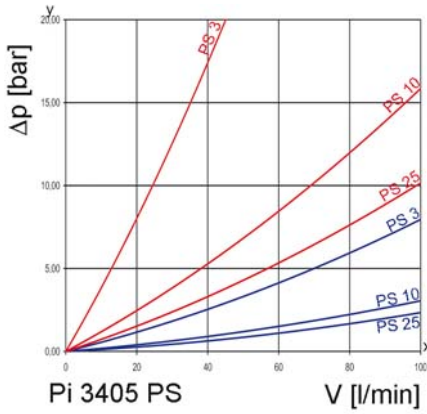

y = differential pressure  $\Delta p$  [bar]  
 x = flow rate V [l/min]

### 3. Separation grade characteristics

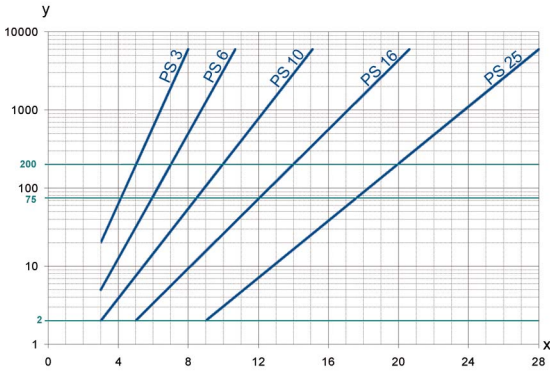

y = beta-value  
x = particle size [ $\mu\text{m}$ ]

determined by multipass tests (ISO 16889)  
calibration according to ISO 11171 (NIST)

### 4. Filter performance data

tested according to ISO 16889 (multipass test)

PS elements with  
max.  $\Delta p$  20 bar

PS	3	$\beta_{5(C)} \geq 200$
PS	6	$\beta_{7(C)} \geq 200$
PS	10	$\beta_{10(C)} \geq 200$
PS	25	$\beta_{20(C)} \geq 200$

values guaranteed up to  
10 bar differential pressure

PS vst elements with  
max.  $\Delta p$  210 bar

PS vst	3	$\beta_{5(C)} \geq 200$
PS vst	6	$\beta_{7(C)} \geq 200$
PS vst	10	$\beta_{10(C)} \geq 200$
PS vst	25	$\beta_{20(C)} \geq 200$

values guaranteed up to  
20 bar differential pressure

### 5. Quality assurance

MAHLE filters and filter elements are produced according to the following international standards:

Norm	Designation
DIN ISO 2941	Hydraulic fluid power filter elements; verification of collapse/burst resistance
DIN ISO 2942	Hydraulic fluid power filter elements; verification of fabrication integrity
DIN ISO 2943	Hydraulic fluid power filter elements; verification of material compatibility with fluids
DIN ISO 3723	Hydraulic fluid power filter elements; method for end load test
DIN ISO 3724	Hydraulic fluid power filter elements; verification flow fatigue characteristics
ISO 3968	Hydraulic fluid power filters; evaluation of pressure drop versus flow characteristics
ISO 10771.1	Fatigue pressure testing of metal containing envelopes in hydraulic fluid applications
ISO 16889	Hydraulic fluid power filters; multipass method for evaluation filtration performance of a filter element

### 6. Symbols

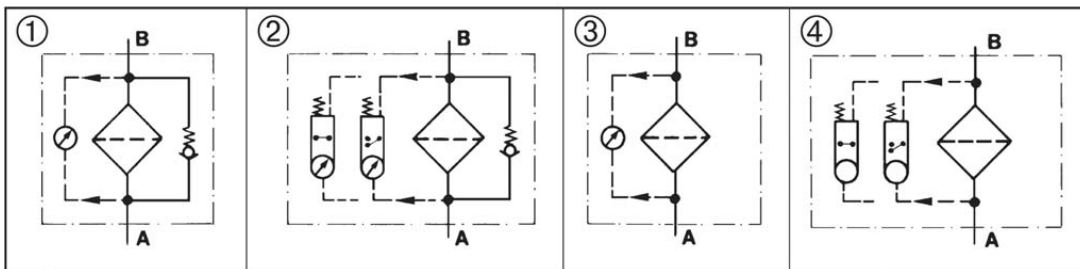

## 7. Order numbers

Example for ordering filters:

1. Filter housing	2. Filter element
V = 80 l/min and electrical maintenance indicator Type: Pi 3408-015 Order number: 77874415	PS vst 3 Type: Pi 2208 PS vst 3 Order number: 77680200

### 7.1 Housing design

Nominal size NG [l/min]	Order number	Type	①	②	③	④
			with bypass valve and visual indicator	with bypass valve and electrical indicator	with visual indicator	with electrical indicator
50	77874324	Pi 3405-012				
	77874332	Pi 3405-013				
	77874340	Pi 3405-014				
	77874357	Pi 3405-015				
80	77874381	Pi 3408-012				
	78274136	Pi 3408-013				
	77874407	Pi 3408-014				
	77874415	Pi 3408-015				
110	77874449	Pi 3411-012				
	77874456	Pi 3411-013				
	77874464	Pi 3411-014				
	77874472	Pi 3411-015				
150	77921919	Pi 3415-012				
	77921927	Pi 3415-013				
	77921935	Pi 3415-014				
	77921943	Pi 3415-015				
300	77921968	Pi 3430-012				
	77921976	Pi 3430-013				
	77921984	Pi 3430-014				
	77921992	Pi 3430-015				
450	77922008	Pi 3445-012				
	77922016	Pi 3445-013				
	77922024	Pi 3445-014				
	77922032	Pi 3445-015				

When filter with non bypass configuration is selected, the collapse pressure of the element must not be exceeded.

**7.2 Filter elements (a wider range of element types is available on request)**

Nominal size NG [l/min]	Order number	Type	Filter material	max. $\Delta p$ [bar]	Filter surface [cm <sup>2</sup> ]
50	77680135	Pi 2105 PS 3	PS 3	20	590
	77943509	Pi 5105 PS 6	PS 6		590
	77680325	Pi 3105 PS 10	PS 10		590
	77680440	Pi 4105 PS 25	PS 25		590
	77680192	Pi 2205 PS vst 3	PS vst 3	210	425
	77943533	Pi 5205 PS vst 6	PS vst 6		425
	77680382	Pi 3205 PS vst 10	PS vst 10		425
	77680507	Pi 4205 PS vst 25	PS vst 25		425
80	77680143	Pi 2108 PS 3	PS 3	20	1150
	77943517	Pi 5108 PS 6	PS 6		1150
	77680341	Pi 3108 PS 10	PS 10		1150
	77680457	Pi 4108 PS 25	PS 25		1150
	77680200	Pi 2208 PS vst 3	PS vst 3	210	850
	77943541	Pi 5208 PS vst 6	PS vst 6		850
	77681190	Pi 3208 PS vst 10	PS vst 10		850
	77680515	Pi 4208 PS vst 25	PS vst 25		850
110	77680150	Pi 2111 PS 3	PS 3	20	1700
	77943525	Pi 5111 PS 6	PS 6		1700
	77680333	Pi 3111 PS 10	PS 10		1700
	77680465	Pi 4111 PS 25	PS 25		1700
	77680218	Pi 2211 PS vst 3	PS vst 3	210	1275
	77943558	Pi 5211 PS vst 6	PS vst 6		1275
	77680390	Pi 3211 PS vst 10	PS vst 10		1275
	77680523	Pi 4211 PS vst 25	PS vst 25		1275
150	77680168	Pi 2115 PS 3	PS 3	20	2425
	77955099	Pi 5115 PS 6	PS 6		2425
	77680358	Pi 3115 PS 10	PS 10		2425
	77680473	Pi 4115 PS 25	PS 25		2425
	77680226	Pi 2215 PS vst 3	PS vst 3	210	2010
	77955123	Pi 5215 PS vst 6	PS vst 6		2010
	77680408	Pi 3215 PS vst 10	PS vst 10		2010
	77680531	Pi 4215 PS vst 25	PS vst 25		2010
300	77680176	Pi 2130 PS 3	PS 3	20	4620
	77955107	Pi 5130 PS 6	PS 6		4620
	77680366	Pi 3130 PS 10	PS 10		4620
	77680481	Pi 4130 PS 25	PS 25		4620
	77680234	Pi 2230 PS vst 3	PS vst 3	210	3800
	77955131	Pi 5230 PS vst 6	PS vst 6		3800
	77680416	Pi 3230 PS vst 10	PS vst 10		3800
	77680549	Pi 4230 PS vst 25	PS vst 25		3800
450	77680184	Pi 2145 PS 3	PS 3	20	6865
	77955115	Pi 5145 PS 6	PS 6		6865
	77680374	Pi 3145 PS 10	PS 10		6865
	77680499	Pi 4145 PS 25	PS 25		6865
	77680242	Pi 2245 PS vst 3	PS vst 3	210	5600
	77955149	Pi 5245 PS vst 6	PS vst 6		5600
	77680424	Pi 3245 PS vst 10	PS vst 10		5600
	77680556	Pi 4245 PS vst 25	PS vst 25		5600

## 8. Technical specifications

Design:	flange filter
Nominal pressure:	250 bar (3560 psi)
Pi 3405-3411	350 bar (4980 psi)
Pi 3415-3445 without bypass	315 bar (4480 psi)
Test pressure:	325 bar (4620 psi)
Pi 3405-3411	450 bar (6400 psi)
Pi 3415-3445 without bypass	410 bar (5830 psi)
Temperature range:	-10 °C to +120 °C
	(other temperature ranges on request)
Bypass setting:	$\Delta p$ 7 bar $\pm$ 10 %
Filter head material:	GGG
Filter housing material:	St
Sealing material:	NBR/PTFE
Maintenance indicator setting:	$\Delta p$ 5 bar $\pm$ 10 %
Electrical data of maintenance indicator:	
Maximum voltage:	250 V AC/200 V DC
Maximum current:	1 A
Contact load:	70 W
Type of protection:	IP 65 in inserted and secured status
Contact:	normally open/closed
Cable sleeve:	M20x1.5

The switching function can be changed by turning the electric upper part by 180° (normally closed contact or normally open contact). The state on delivery is a normally closed contact. By the inductivity in the direct current circuit the use of suitable protection circuit should be considered. Further maintenance indicator details and designs are available in the maintenance data sheet.

We draw attention to the fact that all values indicated are average values and do not always occur in specific cases of application. Our products are continually being further developed. Values, dimensions and weights can change as a result of this. Our specialized department will be pleased to offer you advice.

We recommend you to contact us concerning applications of our filters in areas governed by the EU Directive 94/9 EC (ATEX 95). The standard version can be used for liquids based on mineral oil (corresponding to the fluids in Group 2 of Directive 97/23 EC Article 9). If you consider to use other fluids please contact us for additional support.

Subject to technical alteration without prior notice.

## 9. Dimensions

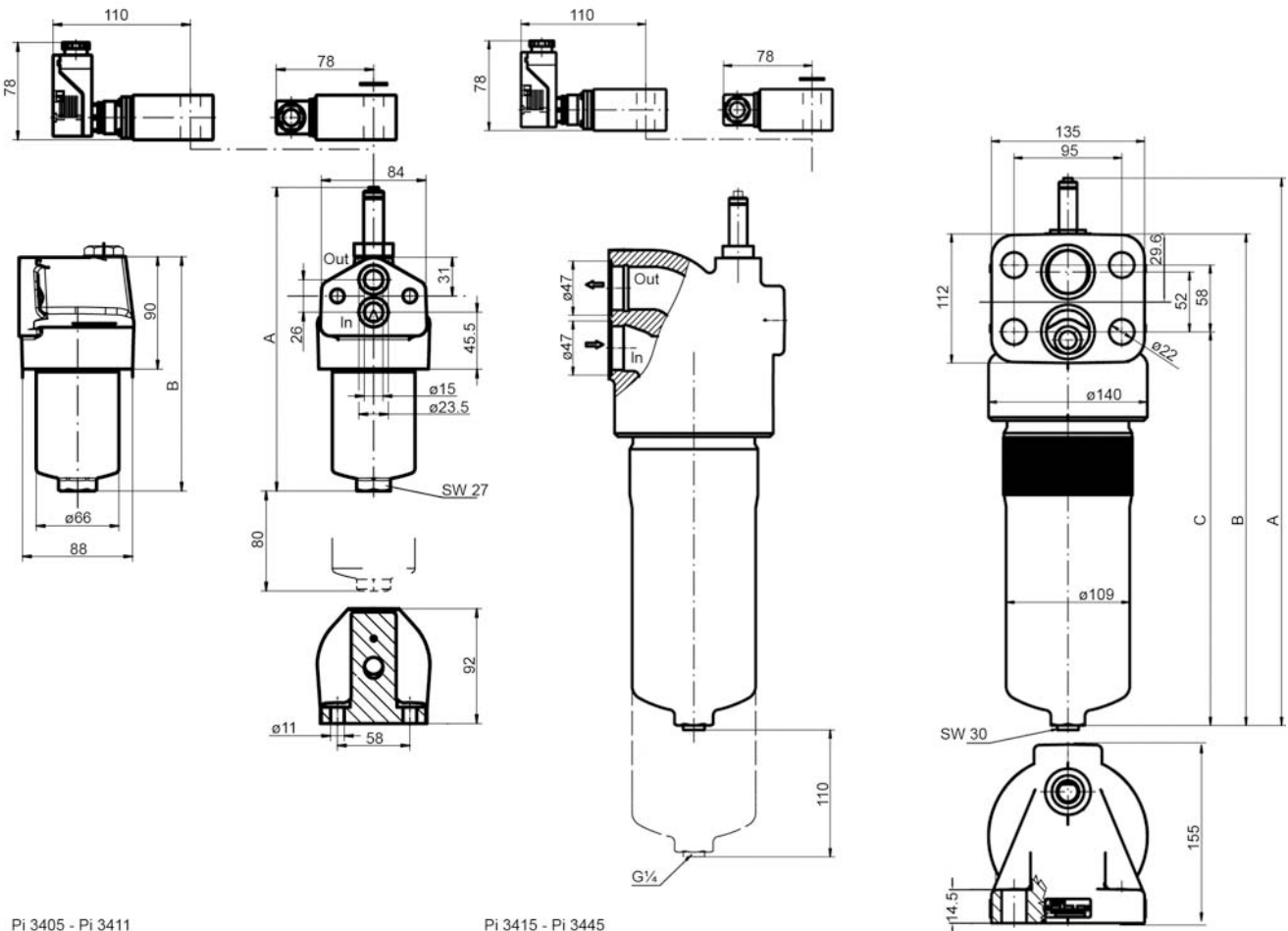

Pi 3405 - Pi 3411

Pi 3415 - Pi 3445

In = inlet  
Out = outlet

Attachment screws (property class 12.9) are not included in the delivery.

All dimensions in mm.

Type	A	B	C	Weight [kg]
Pi 3405	241	188	-	3.7
Pi 3408	320	265	-	4.7
Pi 3411	395	342	-	5.5
Pi 3415	360	305	227	14.4
Pi 3430	474	419	341	17.3
Pi 3445	590	535	457	19.4

## 10. Installation, operating and maintenance instructions

### 10.1 Filter installation

When installing the filter make sure that sufficient space is available to remove filter element and filter housing. Preferably the filter should be installed with the filter housing pointing downwards. The maintenance indicator must be visible.

### 10.2 Connecting the electrical maintenance indicator

The electrical connection is connected via a 2-pole appliance plug according to DIN EN 175301-803 with poles marked 1 and 2. The electrical section can be inverted to change from normally open position to normally closed position or vice versa.

### 10.3 When should the filter element be replaced?

- Filters equipped with visual and electrical maintenance indicator:  
During cold starts, the indicator may give a warning signal. Press the red button of the visual indicator once again only after operating temperature has been reached. If the red button immediately pops up again and/or the electrical signal has not switched off after reaching operating temperature, the filter element must be replaced after the end of the shift.
- Filters without maintenance indicator:  
The filter element should be replaced after the trial run or flushing of the system. Afterwards follow instructions of the manufacturer.
- Please always ensure that you have original MAHLE spare elements in stock: Disposable elements (PS) cannot be cleaned.

### 10.4 Element replacement

- Stop system and relieve filter from pressure.
- Filter sizes 300 and 450: empty the filter housing by removing the drain plug.
- Unscrew the filter housing by turning counter-clockwise. Clean the housing using a suitable cleaning solvent.
- Remove element by pulling down carefully.
- Check o-ring, spigot and o-ring in the element locator for damage. Replace, if necessary.
- Make sure that the order number on the spare element corresponds to the order number of the filter name-plate.  
To ensure no contamination occurs during the exchange of the element first open the plastic bag and push the element over the spigot in the filter head. Now remove plastic bag.
- Lightly lubricate the threads of the filter housing a little bit and screw into the filter head. Maximum tightening torque for NG 50 to 110 = 60 Nm, for NG 150 to 450 = 100 Nm.
- Check seals of vent drain plug - if necessary, please replace. Torque drain plug 30 Nm.

## 11. Spare parts list

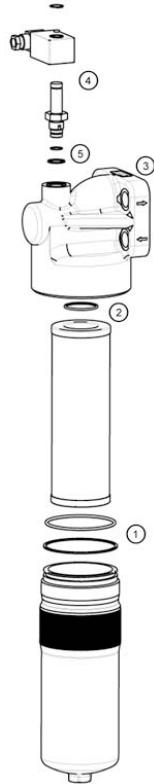

Order numbers for spare parts		
Position	Type	Order number
① bis ③	Seal kit for filter	
	<b>Pi 3405 - Pi 3411</b>	
	NBR	77850381
	FPM	77850399
	EPDM	77850407
	<b>Pi 3415 - Pi 3445</b>	
	NBR	77936206
	FPM	77936214
	EPDM	77936222
④	Maintenance indicator	
	Visual 5 bar PiS 3093/5	77669914
	Electrical 5 bar PiS 3092/5	77669864
	Electrical upper section only	77536550
⑤	Seal kit for maintenance indicator	
	NBR	77760275
	FPM	77760283
	EPDM	77760291

MAHLE Industriefiltration GmbH  
 Schleifbachweg 45  
 74613 Öhringen  
 Phone +49 7941 67-0  
 Fax +49 7941 67-23429  
 industrialfiltration@mahle.com  
 www.mahle-industrialfiltration.com  
 78356750.03/2012